

Product benefits

- The ideal solution for the modern kitchen – suitable for integrating into most kitchens
- Refrigeration solution below the worktop – frees up space on the worktop and facilitates access to refrigerated foods
- Maintains the neat, low lines in the kitchen
- Ideal solution for wheelchair users, too
- 2-10°C temperature range
- 2 large drawers + 1 cold cut drawer
- Completely maintenance-free with automatic defrosting
- Niche measurements: W800 / H825 (min.) / D565 mm

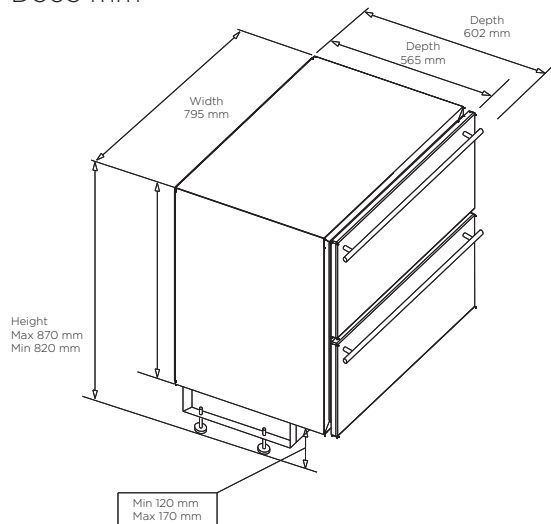

Drawer fridge with steel front or matte black front

Models

- 1 Drawer fridge
Product Code: 60000006
- 2 Matte black front for drawer fridge
Product Code: 8900013831
- 3 Steel front for drawer fridge
Product Code: 8900013832

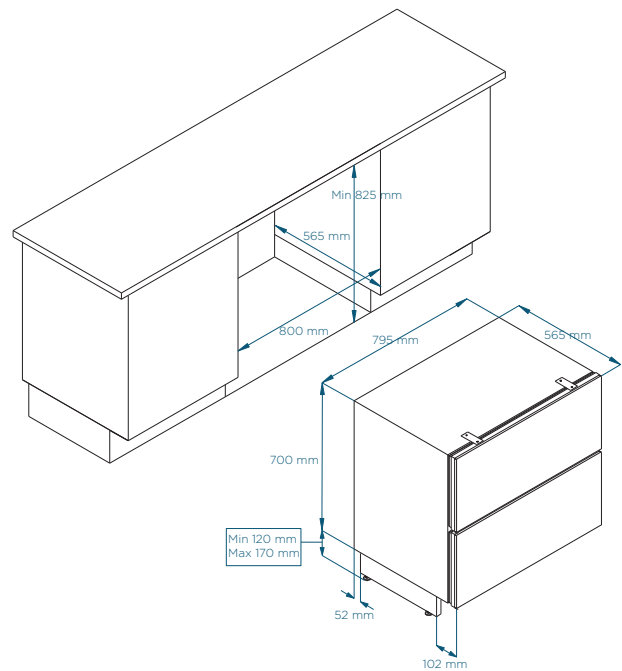

Drawer fridge for fitting furniture front.
Recommended measurements for the furniture fronts to be fitted:

Width: 795 mm Height: 341-347 mm

Technical Data

Dimensions		Temperature		Drawers	
External measurements (mm)	W795 x H820-870 x D565	Temperature range	2-10°C	Number of drawers	2+1
Niche measurements (mm)	W800 x H825 x D565 (min.)	Ambient temperature	16-32°C	2 large drawers (external) and 1 smaller one (internal)	
Weight (kg)	65	Energy		Front panels for drawer	
Net volume (litres)	104	Consumption (kWh/year)	116.44	Furniture front, steel front or matte black front	
For integrating	Yes	Energy class	D	Ventilation	
		Lighting	Yes	Requires ventilation	Yes, see user manual